

MASTIC HOME EXTERIORS

PERFORMANCE METALS[®]

SIDING • SOFFIT • FASCIA • TRIM SHEET
TRIM COIL • GUTTER • DOWNSPOUTS AND ACCESSORIES

MASTIC[®] | PERFORMANCE METALS[®]

HOME EXTERIORS
by PLY GEM

AN INDUSTRY LEADER IN QUALITY AND PERFORMANCE.

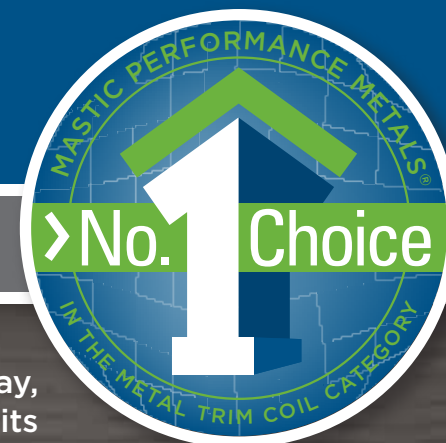

Thanks to more than 30 years of extensive testing — and our proprietary Alunalure[®] 2000 finish — our Performance Metals[®] remain the premier metal product in the industry. Yesterday, today and tomorrow — Performance Metals boast the same superior quality, features, benefits and performance you've come to expect from Mastic Home Exteriors aluminum products.



ALUNALURE
2000

QUALITY PERFORMANCE

ALUNALURE[®] 2000 is an exceptional two-coat finish that holds its color and resists corrosion. It outperforms the competition in the harshest weather conditions.



LIFETIME WARRANTY

The peace of mind of one comprehensive warranty that covers material and labor with a 100% coverage schedule for the lifetime of the original owner



LOW MAINTENANCE

Won't chip, flake or blister, crack or split when bent and shaped. It cuts clean without burrs and applies flatter with no buckles, ripples, waves or "oil-canning".



COLOR COORDINATION

50+ Standard Colors. Match or coordinate with all Mastic products and most major cladding brands. Inorganic pigments mean colors stay true and last longer.

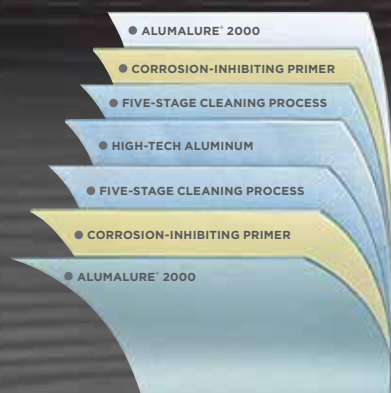

Test our metal. We do. Rigorously. Relentlessly.



WEATHERING Color retention (resistance to fading) is tested by subjecting Mastic products to real-time weather conditions and accelerated UV testing. This ensures that Mastic products will hold up in the most extreme environmental conditions.



RIGIDITY Panels are designed and engineered to be more rigid so the siding remains straight on the wall.



COLOR READ TEST Using a spherical spectrophotometer, a 10,000 watt xenon flash tube bounces light off a siding panel. This information is then analyzed to determine if the color falls within accepted ranges for color consistency and match.



VERTICAL HEIGHT IMPACT TEST Measures the product's durability and ability to resist impact forces — the result of proper thickness, formulation and impact modifiers.



GLOSS TEST A digital readout microgloss meter is used to scan siding to determine if its gloss falls within a target range. Gloss is important to the aesthetic appeal of the siding.



SUN EXPOSURE TEST



ALUMALURE[®] 2000

Competitor's Polyester



ACCELERATED CORROSION TEST

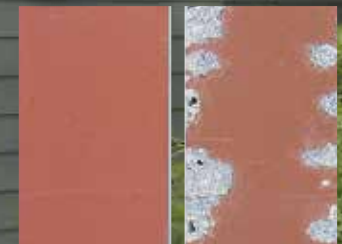

ALUMALURE[®] 2000

Single-coat polyester over metal from a scrap-based mini-mill

MASTIC HOME EXTERIORS

PERFORMANCE METALS® ENVOY® ALUMINUM SIDING

SINGLE 8" • DOUBLE 4" • DOUBLE 5"



HIGH-PERFORMANCE LOCKING SYSTEM

Provides greater stability and increased locking area.

STRONG NAIL HEM

Secure fastening — added strength and stability.



WIND SPEED — RATED UP TO 165 MPH

PERFORMANCE METALS ALUMINUM SIDING

Faster, easier cutting = faster, easier installation.

1/2" PANEL PROJECTION

Enhanced shadow lines replicate the appearance of real wood siding.



NOMINAL .024 THICKNESS



AVAILABLE IN 10 COLORS

See Product Spec Guide for complete details.



ALUMALURE® 2000

This revolutionary finish holds its color and resists the toughest corrosive elements — even UV radiation and polluted air. Applied in a two-coat process, AlumaLure® 2000 is a combination of corrosion-inhibiting primer and an ultra-tough, low-mar topcoat.



V.I.P. LIMITED LIFETIME WARRANTY

Premium guarantee of lasting quality and peace of mind — backed by Mastic, a trusted industry leader for 50+ years (see warranty for complete details).

MASTIC HOME EXTERIORS

PERFORMANCE METALS® ENDURANCE® ALUMINUM SIDING

DOUBLE 4" • DOUBLE 5" DUTCH LAP



HIGH-PERFORMANCE LOCKING SYSTEM

Provides greater stability and increased locking area.

STRONG NAIL HEM

Secure fastening — added strength and stability.

165
MPH

WIND SPEED — RATED UP TO 165 MPH

PERFORMANCE METALS ALUMINUM SIDING

Faster, easier cutting = faster, easier installation.

1/2" PANEL PROJECTION

Enhanced shadow lines replicate the appearance of real wood siding.



AVAILABLE IN 10 COLORS

See Product Spec Guide for complete details.



ALUMALURE® 2000

This revolutionary finish holds its color and resists the toughest corrosive elements — even UV radiation and polluted air. Applied in a two-coat process, AlumaLure® 2000 is a combination of corrosion-inhibiting primer and an ultra-tough, low-mar topcoat.



V.I.P. LIMITED LIFETIME WARRANTY

Premium guarantee of lasting quality and peace of mind — backed by Mastic, a trusted industry leader for 50+ years (see warranty for complete details).

MASTIC HOME EXTERIORS

PERFORMANCE METALS® ENVOY® ALUMINUM SOFFIT

V-GROOVE • SINGLE 6" • DOUBLE 6" U-GROOVE • DOUBLE 6" • TRIPLE 4" • QUAD 4"

Manufactured from only the highest-grade aluminum, Envoy, our strongest and hardest aluminum soffit, meets or exceeds Q801 standards — delivering rigid performance across long spans.



V-GROOVE

- Our v-groove designs replicate the classic look of tongue-and-groove wood soffit more closely than any other metal soffit system.
- The industry's only v-groove in a 6" width, our design helps eliminate sagging and nail facing — a big plus.
- Perforated v-groove offers the most net free ventilation per lineal foot of any aluminum soffit system.



U-GROOVE

- Wider grooves cast a more subtle shadow.
- Helps hide construction imperfections.



AVAILABLE IN UP TO 29 COLORS

See Product Spec Guide for complete details.



ALUMALURE® 2000

This revolutionary finish holds its color and resists the toughest corrosive elements — even UV radiation and polluted air. Applied in a two-coat process, Alumalure® 2000 is a combination of corrosion-inhibiting primer and an ultra-tough, low-mar topcoat.



V.I.P. LIMITED LIFETIME WARRANTY

Premium guarantee of lasting quality and peace of mind — backed by Mastic, a trusted industry leader for 50+ years (see warranty for complete details).

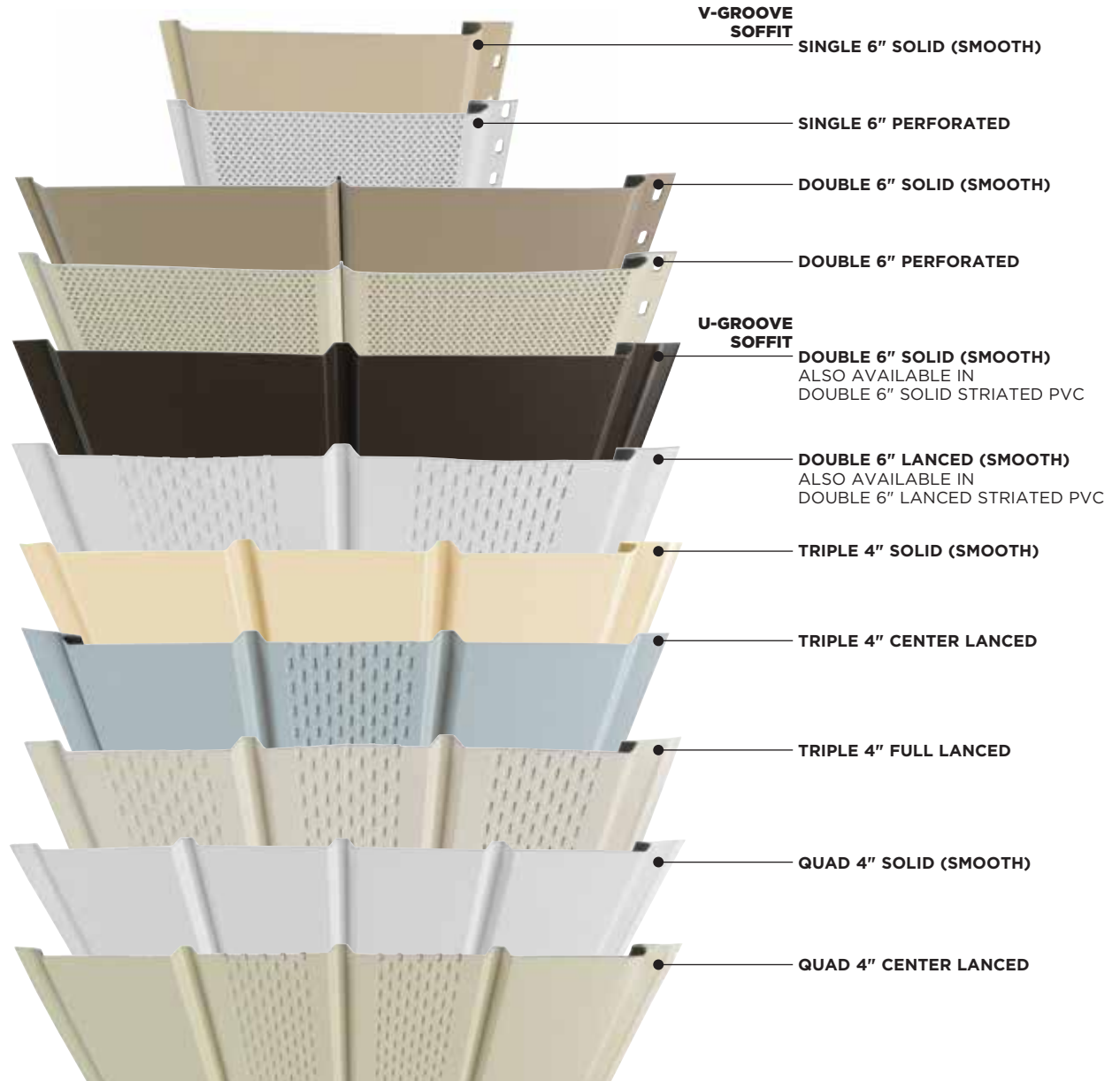

MASTIC HOME EXTERIORS

PERFORMANCE METALS® ENDURANCE® ALUMINUM SOFFIT

V-GROOVE • DOUBLE 6" U-GROOVE • DOUBLE 6" • TRIPLE 4"

Engineered for outstanding strength and superior ventilation performance, Endurance represents a great value in a low-maintenance soffit.



V-GROOVE

- Our v-groove designs replicate the classic look of tongue-and-groove wood soffit more closely than any other metal soffit system.
- The industry's only v-groove in a 6" width, our design helps eliminate sagging and nail facing — a big plus.
- Perforated v-groove offers the most net free ventilation per lineal foot of any aluminum soffit system.



U-GROOVE

- Wider grooves cast a more subtle shadow.
- Helps hide construction imperfections.



AVAILABLE IN UP TO 30 COLORS

See Product Spec Guide for complete details.



ALUMALURE® 2000

This revolutionary finish holds its color and resists the toughest corrosive elements — even UV radiation and polluted air. Applied in a two-coat process, Alumalure® 2000 is a combination of corrosion-inhibiting primer and an ultra-tough, low-mar topcoat.



V.I.P. LIMITED LIFETIME WARRANTY

Premium guarantee of lasting quality and peace of mind — backed by Mastic, a trusted industry leader for 50+ years (see warranty for complete details).

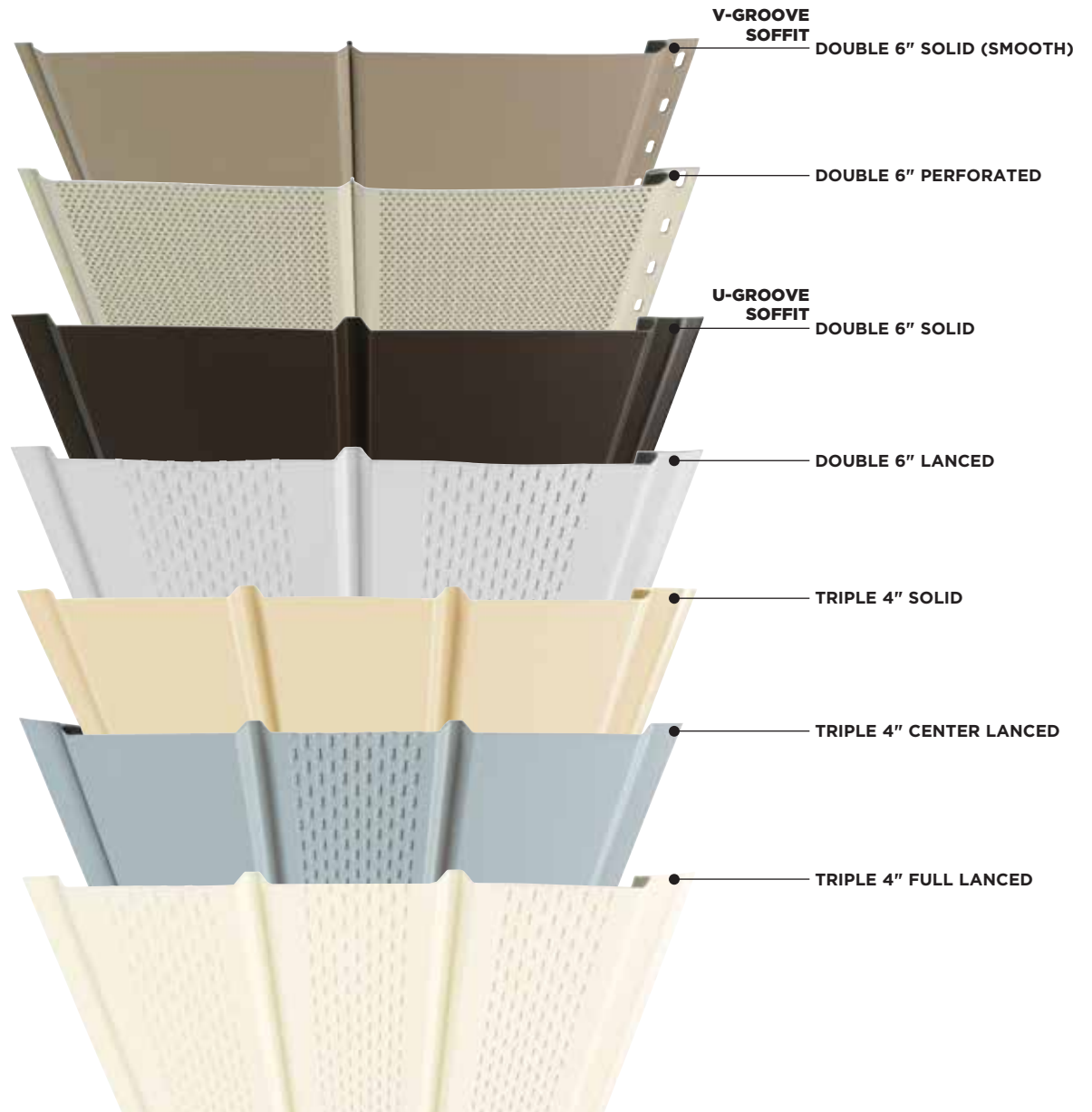

MASTIC HOME EXTERIORS

PERFORMANCE METALS[®]

ECONOMY ALUMINUM SOFFIT

U-GROOVE • TRIPLE 4"

Durable and economical, Economy Soffit offers efficient performance in ventilated and non-ventilated styles.



U-GROOVE

- Wider grooves cast a more subtle shadow.
- Helps hide construction imperfections.



AVAILABLE IN WHITE



ALUMALURE[®] 2000

This revolutionary finish holds its color and resists the toughest corrosive elements — even UV radiation and polluted air. Applied in a two-coat process, AlumaLure[®] 2000 is a combination of corrosion-inhibiting primer and an ultra-tough, low-mar topcoat.

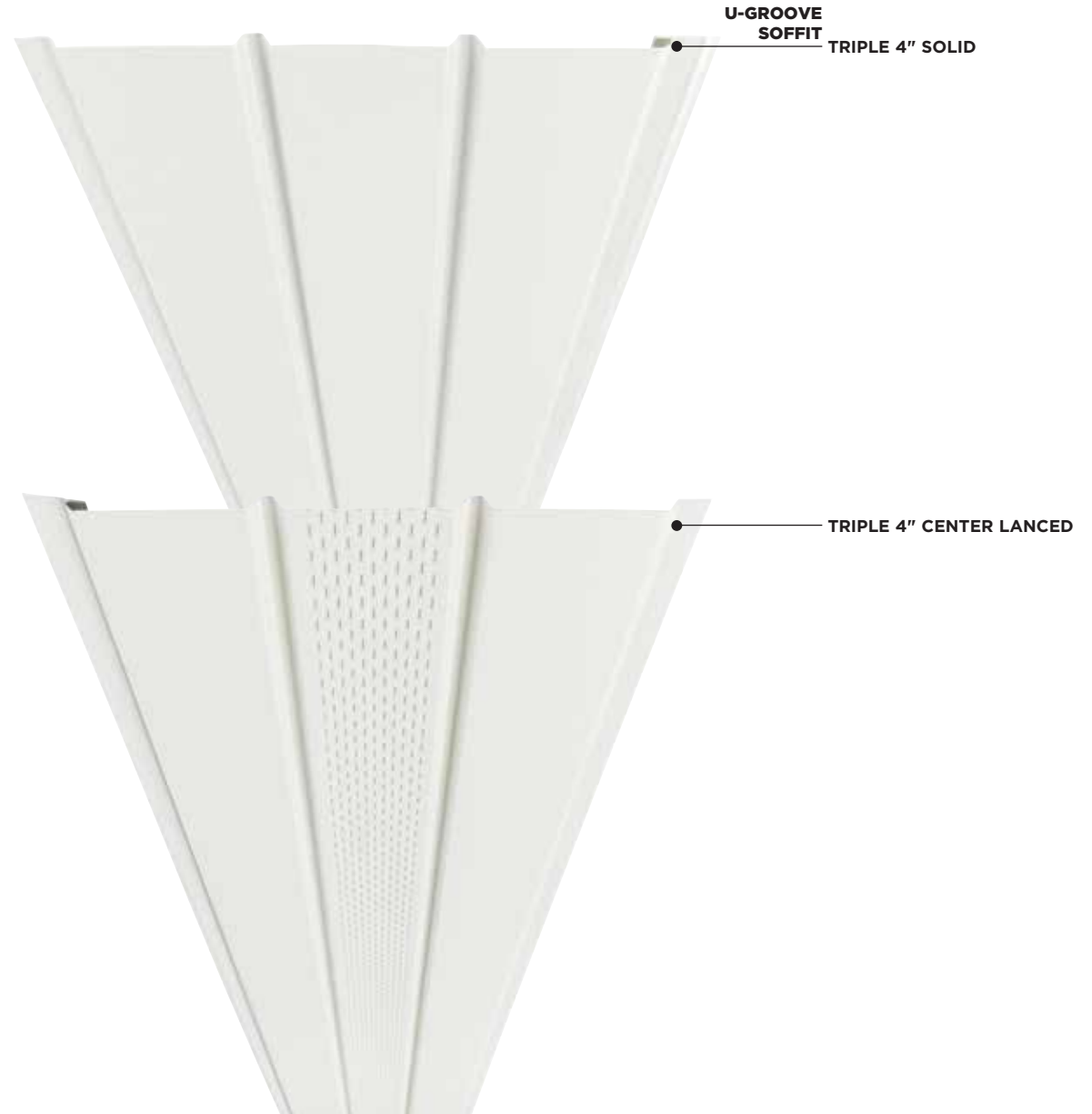

MASTIC HOME EXTERIORS

PERFORMANCE METALS®

ENVOY® + ENDURANCE® FASCIA

ENVOY FASCIA • SMOOTH • WOODGRAIN • RIBBED • PVC COATED ENDURANCE FASCIA • RIBBED

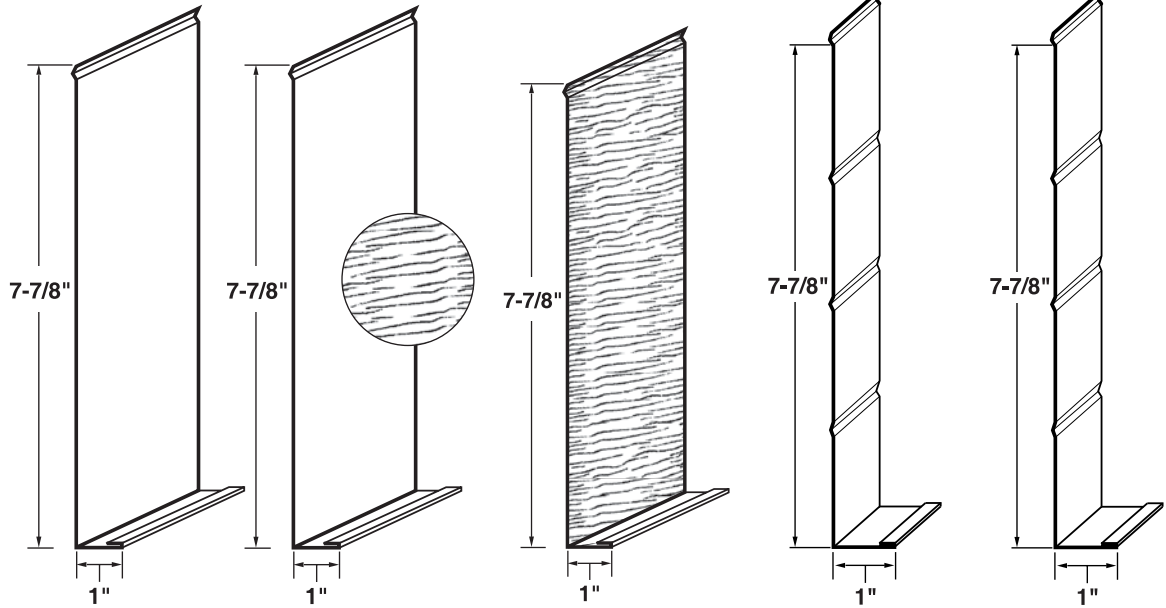

**ENVOY
SMOOTH
FASCIA TRIM**
4", 6", 8", 10"
.024 NOMINAL

**ENVOY
PVC COATED
FASCIA TRIM**
6", 8"
.024 NOMINAL
(NOT ALUMALURE® 2000)

**ENVOY
WOODGRAIN
EMBOSSED
FASCIA TRIM**
4", 6", 8", 10"
.024 NOMINAL

**ENVOY
RIBBED
FASCIA TRIM**
4", 6", 8", 10"
.024 NOMINAL

**ENDURANCE
RIBBED
FASCIA TRIM**
4", 6", 8", 10"
.019 NOMINAL



AVAILABLE IN 29 COLORS

See Product Spec Guide for complete details.



ALUMALURE® 2000

This revolutionary finish holds its color and resists the toughest corrosive elements — even UV radiation and polluted air. Applied in a two-coat process, Alupalure® 2000 is a combination of corrosion-inhibiting primer and an ultra-tough, low-mar topcoat.



STRIATED PVC FINISH

This richly textured finish mimics the look of freshly painted wood. Thicker and more durable than most PVC finishes, it is composed of surface-conditioned high-quality aluminum covered by an all-weather super-flexible primer topped by a thick film of textured PVC topcoat. This premium construction provides exceptional scratch-resistance, durability, and long-term performance.



V.I.P. LIMITED LIFETIME WARRANTY

Premium guarantee of lasting quality and peace of mind — backed by Mastic, a trusted industry leader for 50+ years (see warranty for complete details).

MASTIC HOME EXTERIORS PERFORMANCE METALS® TRIM SHEET

ULTRA TS® • ALUMALURE® 2000 TS24 • SMOOTH • ALUMALURE® 2000 TS24T • STRIATED • PVC COATED

NOMINAL
.024
THICKNESS

ULTRA TS® TRIM SHEET

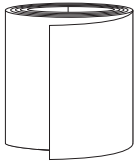

ALUMALURE® 2000
SMOOTH FINISH
24" TRIM SHEET



PVC COATED
STRIATED FINISH
24" TRIM SHEET



BENDS EASILY — WITHOUT RISK OF CRACKING

**PREMIUM LOW-MAR TOPCOAT RESISTS CRACKING,
CHALKING AND FADING**

**LONG RUNS OF MATERIAL —
WITH NO RIPPLES, WAVES OR "OIL-CANNING"**

NOMINAL
.019
THICKNESS

TRIM SHEET

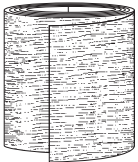

PVC COATED
STRIATED FINISH
24" TRIM SHEET



PVC COATED
TEXTURE FINISH
24" TRIM SHEET

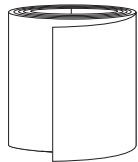

ALUMALURE® 2000
SMOOTH FINISH
24" TRIM SHEET

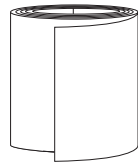

ALUMALURE® 2000
SMOOTH FINISH
24" TRIM SHEET
150' LONG



ALUMALURE® 2000
SMOOTH FINISH
20" TRIM SHEET



ALUMALURE® 2000
SMOOTH FINISH
18" TRIM SHEET

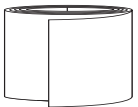

ALUMALURE® 2000
SMOOTH FINISH
16" TRIM SHEET



ALUMALURE® 2000
SMOOTH FINISH
14" TRIM SHEET

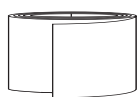

ALUMALURE® 2000
SMOOTH FINISH
12" TRIM SHEET

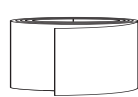

ALUMALURE® 2000
SMOOTH FINISH
10" TRIM SHEET

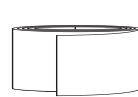

ALUMALURE® 2000
SMOOTH FINISH
8" TRIM SHEET

CORROSION-INHIBITING PRIMER — COMBINED WITH LOW-MAR TOPCOAT

Stands up to extreme weather — resists fading, chalking, corrosion and UV damage.

SUPERIOR ELONGATION AND YIELD STRENGTH

Easily shaped and formed on the job site.

THE HIGHEST-QUALITY ALUMINUM TRIM SHEET AVAILABLE FOR RESIDENTIAL CONSTRUCTION

PERFORMANCE METALS ALUMINUM TRIM SHEET

Faster, easier cutting = faster, easier installation.



**OFFERED IN AN EXTENSIVE ARRAY OF COLORS, THIS SUPER-
PREMIUM TRIM SHEET DELIVERS OUTSTANDING JOB-SITE
PERFORMANCE — AND SMOOTH, BUCKLE-FREE APPLICATION**

- 50+ Standard colors
- Coordinating colors available for popular windows and competitor siding



ALUMALURE® 2000

This revolutionary finish holds its color and resists the toughest corrosive elements — even UV radiation and polluted air. Applied in a two-coat process, Alupalure® 2000 is a combination of corrosion-inhibiting primer and an ultra-tough, low-mar topcoat.



STRIATED PVC FINISH

This richly textured finish mimics the look of freshly painted wood. Thicker and more durable than most PVC finishes, it is composed of surface-conditioned high-quality aluminum covered by an all-weather super-flexible primer topped by a thick film of textured PVC topcoat. This premium construction provides exceptional scratch-resistance, durability, and long-term performance.



V.I.P. LIMITED LIFETIME WARRANTY

Premium guarantee of lasting quality and peace of mind — backed by Mastic, a trusted industry leader for 50+ years (see warranty for complete details).

Also available in a variety of colors to match competitors' vinyl siding. See Product Spec Guide for details.



MASTIC HOME EXTERIORS PERFORMANCE METALS® TRIM COIL

STANDARD • S24 • S24T ECONOMY • EC24 • EC24T

NOMINAL
.019
THICKNESS

STANDARD TRIM COIL

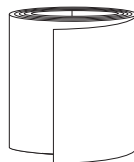

S24
ALUMALURE® 2000
SMOOTH FINISH
24" TRIM COIL



S14
ALUMALURE® 2000
SMOOTH FINISH
14" TRIM COIL



S24T
PVC COATED
STRIATED FINISH
24" TRIM COIL

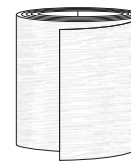

S24LM
LOW-MAR POLYMER
TEXTURE FINISH
24" TRIM COIL

Also available in a variety of colors to match competitors' vinyl siding.

NOMINAL
.018
THICKNESS

ECONOMY TRIM COIL

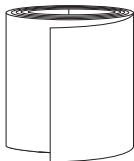

EC24
POLYMER COATED
SMOOTH FINISH
24" TRIM COIL

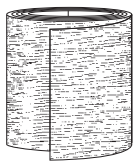

EC24T
PVC COATED
STRIATED FINISH
24" TRIM COIL



AVAILABLE IN 47 COLORS

See Product Spec Guide for complete details.



ALUMALURE
2000

ALUMALURE® 2000 (STANDARD TRIM COIL)

This revolutionary finish holds its color and resists the toughest corrosive elements — even UV radiation and polluted air. Applied in a two-coat process, AlumaLure® 2000 is a combination of corrosion-inhibiting primer and an ultra-tough, low-mar topcoat.



STRIATED
PVC FINISH

STRIATED PVC FINISH

This richly textured finish mimics the look of freshly painted wood. Thicker and more durable than most PVC finishes, it is composed of surface-conditioned high-quality aluminum covered by an all-weather super-flexible primer topped by a thick film of textured PVC topcoat. This premium construction provides exceptional scratch-resistance, durability, and long-term performance.

MASTIC HOME EXTERIORS

PERFORMANCE METALS®

SECTIONAL 6" GUTTER

STRONGEST SYSTEM AVAILABLE FOR RESIDENTIAL CONSTRUCTION

Protects homes by supporting up to 50 pounds per lineal foot to handle more heavy rain, snow and other extreme weather than any other gutter.

PERFORMANCE METALS: THE HIGHEST-QUALITY ALUMINUM — MEETS OR EXCEEDS Q801 STANDARDS

Exclusive to Mastic Home Exterior, our high-tech aluminum alloy is stronger and more rigid than the competition's best metal — plus, a double-coating of our proprietary Alupalure® 2000 finish delivers an exceptionally durable, smooth surface.

EXPANSION JOINTS

Engineered for normal expansion and contraction, which can be problematic in longer runs and hip-roof installations — an advantage not available for "seamless" gutters.

HANGERS ENGINEERED TO SUPPORT MORE WEIGHT THAN ORDINARY SPIKES

Keeps the gutter system firmly in position so water won't leak into the home, providing optimum performance over time.

FREE-FLOATING HANGERS

Uniquely designed to allow gutters to slide as they expand and contract, eliminating stress on nails.

ENVOY
SECTIONAL 6"
OG GUTTER
21' — OG21A6
37' — OG37A6



AVAILABLE IN 9 COLORS

See Product Spec Guide for complete details.



ALUPALURE® 2000

This revolutionary finish holds its color and resists the toughest corrosive elements — even UV radiation and polluted air. Applied in a two-coat process, Alupalure® 2000 is a combination of corrosion-inhibiting primer and an ultra-tough, low-mar topcoat.



V.I.P. LIMITED LIFETIME WARRANTY

Premium guarantee of lasting quality and peace of mind — backed by Mastic, a trusted industry leader for 50+ years (see warranty for complete details).

MASTIC HOME EXTERIORS

PERFORMANCE METALS®

GUTTER DOWNSPOUTS + ACCESSORIES FOR ENVOY® SECTIONAL 6" GUTTER

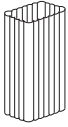

**3" X 4"
RECTANGULAR
CORRUGATED
DOWNSPOUT**
RT34

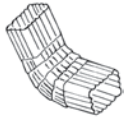

**3" X 4"
STYLE "A"
RECTANGULAR
ELBOW**
RTA74

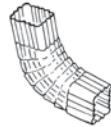

**3" X 4"
STYLE "B"
RECTANGULAR
ELBOW**
RTB74



6" INSIDE MITER
ISM6



6" OUTSIDE MITER
OSM6

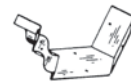

**6" INSIDE
BAY MITER**
ISBAY6
COLOR: PAINTABLE WHITE



**6" OUTSIDE
BAY MITER**
OSBAY6
COLOR: PAINTABLE WHITE

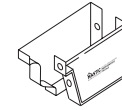

6" END CAPS
OG1565

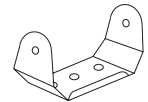

DOWNSPOUT CLIP
(FOR 3" X 4" DOWNSPOUT)
RTA3

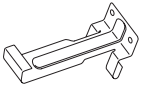

**COMBINATION
HANGER**
OG1061
COLOR: MILL

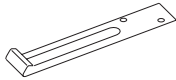

STRAP HANGER
OG1161
COLOR: MILL

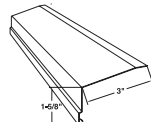

**ROOF APRON,
RECTANGULAR**
RT312

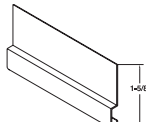

**FASCIA APRON,
RECTANGULAR**
RT412

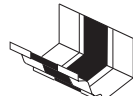

**NEOPRENE
EXPANSION JOINT**
OG256
COLOR: MILL

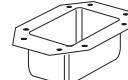

**3" X 4"
RECTANGULAR
EAVE TUBE**
RT24F
COLOR: MILL

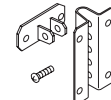

**DOWNSPOUT
ANCHOR CLIP
WITH SCREW**
RT235
COLOR: MILL



**1/8" BLIND POP
RIVETS**
GR1W
COLOR: WHITE



**1/8" BLIND
POP RIVETS**
GR1

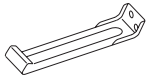

BAR HANGER
OG12R61
COLOR: MILL



ROOF HANGER
OG1361
COLOR: MILL



**6" LEAF RELIEF®
GUTTER
PROTECTION
SYSTEM**
(RETRO-FIT)
TP6300
COLOR: NONE

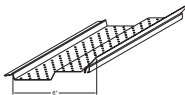

**6" LEAF RELIEF®
GUTTER
PROTECTION
SYSTEM**
(RETRO-FIT)
TP63Z1P
COLOR: NONE
FOR USE OVER OG1061,
OG12R61, ZIP HANGERS

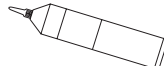

GUTTERSEAL
GS50Z
COLOR: MILL
GSW50Z
COLOR: WHITE

MASTIC HOME EXTERIORS PERFORMANCE METALS® SECTIONAL 5" GUTTER

EXPANSION JOINTS

Engineered for normal expansion and contraction, which can be problematic in longer runs and hip-roof installations — an advantage not available for "seamless" gutters.

PERFORMANCE METALS: THE HIGHEST-QUALITY ALUMINUM — MEETS OR EXCEEDS Q801 STANDARDS

Exclusive to Mastic Home Exterior, our high-tech aluminum alloy is stronger and more rigid than the competition's best metal — plus, a double-coating of our proprietary Alupalure® 2000 finish delivers an exceptionally durable, smooth surface.

HANGERS ENGINEERED TO SUPPORT MORE WEIGHT THAN ORDINARY SPIKES

Keeps the gutter system firmly in position so water won't leak into the home, providing optimum performance over time.

FREE-FLOATING HANGERS

Uniquely designed to allow gutters to slide as they expand and contract, eliminating stress on nails.

ENVOY SECTIONAL 5" OG GUTTER

16' — OG16A
21' — OG21A
26' — OG26
33' — OG33A
37' — OG37A



AVAILABLE IN 9 COLORS

See Product Spec Guide for complete details.



ALUPALURE® 2000

This revolutionary finish holds its color and resists the toughest corrosive elements — even UV radiation and polluted air. Applied in a two-coat process, Alupalure® 2000 is a combination of corrosion-inhibiting primer and an ultra-tough, low-mar topcoat.



LIMITED LIFETIME WARRANTY

Premium guarantee of lasting quality and peace of mind — backed by Mastic, a trusted industry leader for 50+ years (see warranty for complete details).

MASTIC HOME EXTERIORS

PERFORMANCE METALS®

GUTTER DOWNSPOUTS + ACCESSORIES FOR ENVOY® SECTIONAL 5" GUTTER

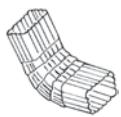

**2" X 3"
STYLE "A"
RECTANGULAR
ELBOW**
45° — RTA4
60° — RTA6
COLOR: WHITE
75° — RTA7

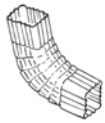

**2" X 3"
STYLE "B"
RECTANGULAR
ELBOW**
60° — RTB6
COLOR: WHITE
75° — RTB7



**3" X 4"
STYLE "A"
RECTANGULAR
ELBOW**
75° — RTA74

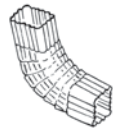

**3" X 4"
STYLE "B"
RECTANGULAR
ELBOW**
75° — RTB74



**2" X 3"
RECTANGULAR
CORRUGATED
DOWNSPOUT**
RT2

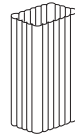

**3" X 4"
RECTANGULAR
CORRUGATED
DOWNSPOUT**
RT34



5" INSIDE MITER
ISM5



5" OUTSIDE MITER
OSM5

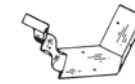

**5" INSIDE
BAY MITER**
ISBAY5
COLOR: PAINTABLE WHITE



**5" OUTSIDE
BAY MITER**
OSBAY5
COLOR: PAINTABLE WHITE

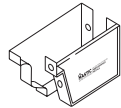

END CAPS
OG155

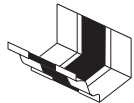

**5" NEOPRENE
EXPANSION JOINT**
OG25
COLOR: MILL

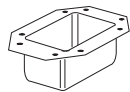

**2" X 3"
RECTANGULAR
EAVE TUBE**
ROT2X3
COLOR: MILL

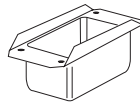

**3" X 4"
RECTANGULAR
EAVE TUBE**
RT241
COLOR: MILL

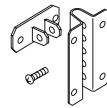

**DOWNSPOUT
ANCHOR CLIP
WITH SCREW**
RT235
COLOR: MILL

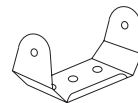

DOWNSPOUT CLIP
(FOR 2" X 3" DOWNSPOUT)
RTA2
COLORS: WHITE, ALMOND,
DESERT SAND, EVERGREEN,
MUSKET BROWN,
PEBBLESTONE CLAY,
SANDTONE, TERRA
BRONZE, VICTORIAN GREY

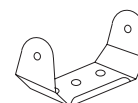

DOWNSPOUT CLIP
(FOR 3" X 4" DOWNSPOUT)
RTA3
COLORS: WHITE,
ALMOND, DESERT SAND,
EVERGREEN, MUSKET
BROWN, PEBBLESTONE
CLAY, SANDTONE, TERRA
BRONZE, VICTORIAN GREY

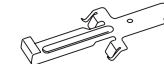

**COMBINATION
STRAP HANGER**
OG141
COLOR: MILL



SNAP-IN HANGER
OG13LR5
COLOR: MILL
USES: LEAF
RELIEF TP5300,
ROOF APRON,
FASCIA APRON

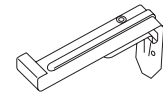

SNUG-FIT HANGER
OG91
COLOR: MILL

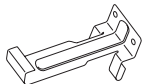

**COMBINATION
HANGER**
OG101

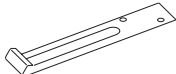

STRAP HANGER
OG111
COLOR: MILL



BAR HANGER
OG12R1
COLOR: MILL



ROOF HANGER
OG131
COLOR: MILL



**1/8" BLIND
POP RIVETS**
GR1W
COLOR: WHITE

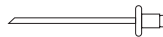

**1/8" BLIND
POP RIVETS**
GR1



**5" LEAF RELIEF®
GUTTER
PROTECTION
SYSTEM**
(RETRO-FIT)
TP5300
COLOR: NONE

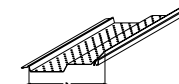

**5" LEAF RELIEF®
GUTTER
PROTECTION
SYSTEM**
(RETRO-FIT FOR ZIP
HANGERS)
TP53ZIP
COLOR: NONE

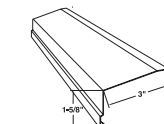

**ROOF APRON,
RECTANGULAR**
RT312
COLORS: WHITE,
ALMOND, DESERT
SAND, EVERGREEN,
MUSKET BROWN,
PEBBLESTONE CLAY,
SANDTONE, TERRA
BRONZE, VICTORIAN
GREY

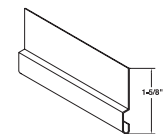

**FASCIA APRON,
RECTANGULAR**
RT412
COLORS: WHITE,
ALMOND, DESERT
SAND, EVERGREEN,
MUSKET BROWN,
PEBBLESTONE CLAY,
SANDTONE, TERRA
BRONZE, VICTORIAN
GREY

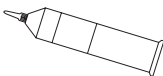

GUTTERSEAL
GS50Z
COLOR: MILL
GSW50Z
COLOR: WHITE

MASTIC HOME EXTERIORS

PERFORMANCE METALS®

GUTTER + DOWNSPOUT COIL

.032 GUTTER COIL



5" GUTTER COIL
ONE-SIDE FINISH COAT
16" CENTER ID

11-3/4" WIDE — GC1175032
11-7/8" WIDE — GC1187532
13" WIDE — GC1300032
DISTRIBUTOR MINIMUM: ONE SKID OF
THREE COILS (ANY COLOR COMBINATION)

SHORT ROLLS
11-3/4" WIDE — SR1175032
11-7/8" WIDE — SR11875032
13" WIDE — SR1300032
MINIMUM: 1 COIL



6" GUTTER COIL
ONE-SIDE FINISH COAT
16" CENTER ID

15" WIDE — GC1500032
DISTRIBUTOR MINIMUM:
TWO COILS/SKID (ANY COLOR
COMBINATION)

SHORT ROLLS
15" WIDE — SR1500032
MINIMUM: 1 COIL

.019 DOWNSPOUT COIL



2" X 3"
DOWNSPOUT COIL
16" CENTER ID

10-1/2" WIDE — DC10500
10-1/2" WIDE — DC105500
DISTRIBUTOR MINIMUM:
TWO COILS/SKID (ANY COLOR
COMBINATION)



3" X 4"
DOWNSPOUT COIL
16" CENTER ID

13-3/4" WIDE — DC13750
13-3/4" WIDE — DC1375500
DISTRIBUTOR MINIMUM: TWO COILS/SKID
(ANY COLOR COMBINATION)

.027 GUTTER COIL



5" GUTTER COIL
ONE-SIDE FINISH COAT
16" CENTER ID

11-3/4" WIDE — GC11750
11-7/8" WIDE — GC11875
DISTRIBUTOR MINIMUM: ONE SKID OF
THREE COILS (ANY COLOR COMBINATION)

SHORT ROLLS
11-3/4" WIDE — SRGC11750
11-7/8" WIDE — SRGC11875
MINIMUM: 1 COIL



6" GUTTER COIL
ONE-SIDE FINISH COAT
16" CENTER ID

15" WIDE — GC15000
DISTRIBUTOR MINIMUM: ONE SKID OF THREE
COILS (ANY COLOR COMBINATION)

SHORT ROLLS
15" WIDE — SRGC15000
MINIMUM: 1 COIL



AVAILABLE IN 24 COLORS,
11 EXTENDED LEAD TIME COLORS
See Product Spec Guide for complete details.



ALUMALURE® 2000

This revolutionary finish holds its color and resists the toughest corrosive elements — even UV radiation and polluted air. Applied in a two-coat process, Alumalure® 2000 is a combination of rust-inhibiting primer and an ultra-tough, low-mar topcoat.



THE ISP™ DIFFERENCE — INTEGRATED STANDARDS OF PERFORMANCE

ISP™ is our comprehensive product development, testing, certification and quality control program. This stringent set of standards and conformance specs ensures products meet or exceed industry standards and/or code approvals. In addition, we go the extra mile with a battery of internal tests designed to predict and scrutinize performance attributes such as tensile strength, rigidity, wind resistance, color fidelity and weatherability.



20-YEAR WARRANTY

MASTIC HOME EXTERIORS

PERFORMANCE METALS®

GUTTER + DOWNSPOUT COIL ACCESSORIES

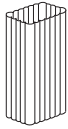

2" X 3" DOWNSPOUT
DS2X3
MINIMUM: ONE CARTON

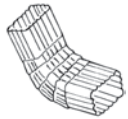

2" X 3" ELBOW STYLE "A"
E2X3A



2" X 3" ELBOW, 30° STYLE "A"
E2X3A30
COLOR: PAINTABLE WHITE

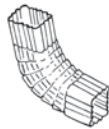

2" X 3" ELBOW STYLE "B"
E2X3B



2" X 3" DOWNSPOUT WITH 1-1/2" OFFSET
LEDGE152X3
COLOR: PAINTABLE WHITE

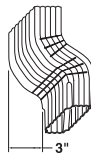

2" X 3" DOWNSPOUT WITH 3" OFFSET
LEDGE302X3
COLOR: PAINTABLE WHITE

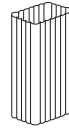

3" X 4" DOWNSPOUT
DS3X4
MINIMUM: ONE CARTON



3" X 4" ELBOW STYLE "A"
E3X4A



3" X 4" ELBOW, 30° STYLE "A"
E3X4A30
COLOR: PAINTABLE WHITE

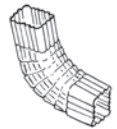

3" X 4" ELBOW STYLE "B"
E3X4B

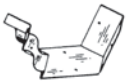

5" INSIDE STRIP MITER
ISM5



5" OUTSIDE STRIP MITER
OSM5

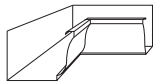

5" INSIDE BOX MITER
IBM5

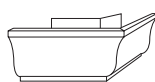

5" OUTSIDE BOX MITER
OBM5



5" INSIDE BAY MITER
ISBAYS



5" OUTSIDE BAY MITER
OSBAYS



5" LEFT END CAPS
EC5L



5" RIGHT END CAPS
EC5R



6" INSIDE STRIP MITER
ISM6



6" OUTSIDE STRIP MITER
OSM6

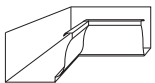

6" INSIDE BOX MITER
IBM6

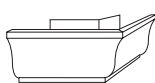

6" OUTSIDE BOX MITER
OBM6



6" INSIDE BAY MITER
ISBAY6



6" OUTSIDE BAY MITER
OSBAY6



6" LEFT END CAPS
EC6L



6" RIGHT END CAPS
EC6R



DOWNSPOUT PIP BAND — UNIVERSAL
(FITS 2" X 3" OR 3" X 4" DOWNSPOUT)
DPB



POP RIVETS
GR1



7" SPIKE — SP7

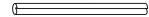

6" FERRULE — FE6
COLOR: MILL

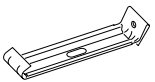

ALUMINUM 5" HIDDEN HANGER
AM5HID
COLOR: MILL

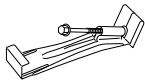

ALUMINUM 5" ZIP HANGER
AM5ZIP500
COLOR: MILL

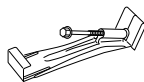

ALUMINUM 6" ZIP HANGER
AM6ZIP
COLOR: MILL

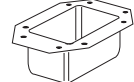

OVAL OUTLET TUBES
2" X 3" — OT2X3
3" X 4" — OT3X4
COLOR: MILL

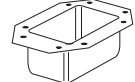

RECTANGULAR OUTLET TUBES
2" X 3" — ROT2X3
3" X 4" — ROT3X4
COLOR: MILL

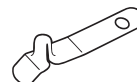

QUICK RELEASE GRC
(ATTACHES EXTENSIONS TO ELBOW)
37211

TOUCH-UP PAINT
12 AEROSOL CANS — GCTU
1 AEROSOL CAN — GCTU1



AVAILABLE IN UP TO 29 COLORS, WITH 21 EXTENDED LEAD TIME COLORS
See Product Spec Guide for complete details.



ALUMALURE® 2000
This revolutionary finish holds its color and resists the toughest corrosive elements — even UV radiation and polluted air. Applied in a two-coat process, Alumalure® 2000 is a combination of corrosion-inhibiting primer and an ultra-tough, low-mar topcoat.



20-YEAR WARRANTY

THE EXTERIOR SOLUTION FOR Color.

57 colors that are classic, unique and distinctive. Deep, dark colors. Boardwalk colors and everything in between. The possibilities are endless. The beauty is timeless.



BLACK



EVERGREEN

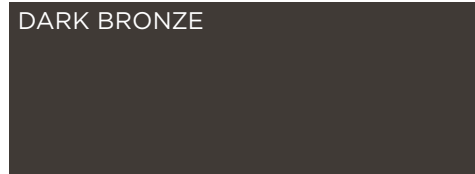

DARK BRONZE

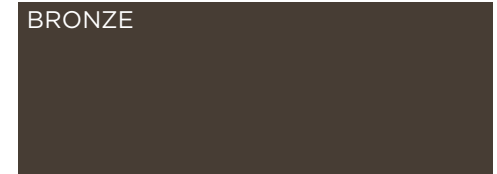

BRONZE

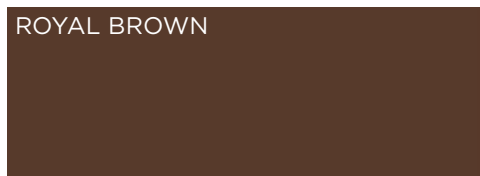

ROYAL BROWN

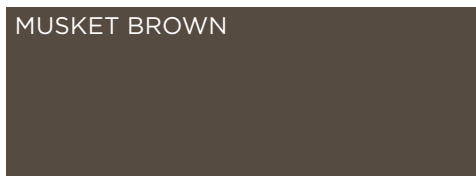

MUSKET BROWN



MISTY SHADOW



RED BRICK

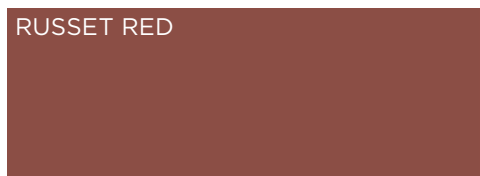

RUSSET RED



MAHOGANY

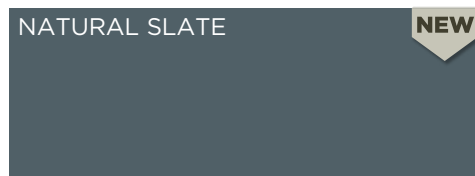

NATURAL SLATE

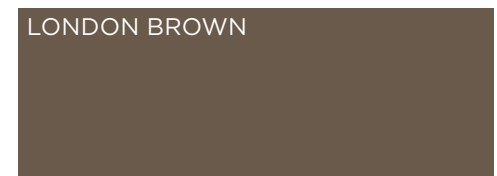

LONDON BROWN

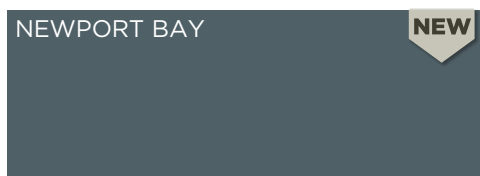

NEWPORT BAY

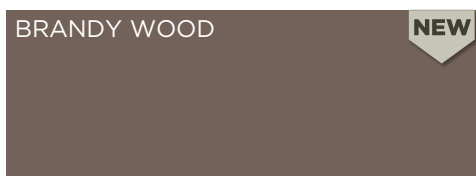

BRANDY WOOD

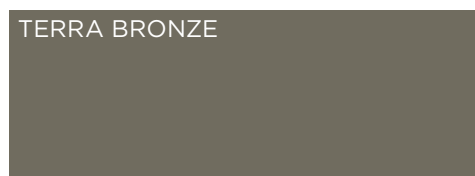

TERRA BRONZE

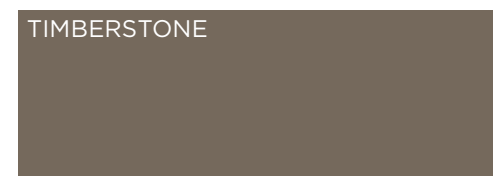

TIMBERSTONE



HAZELWOOD



PORTSMOUTH BLUE



CHARCOAL GREY



MONTANA SUEDE



LAKESHORE FERN



TERRA COTTA



VINEYARD GROVE



GLACIER BLUE

ENGLISH WEDGEWOOD

WOODLAND GREEN

QUIET WILLOW

DEEP GRANITE

RUGGED CANYON

AMERICAN WALNUT

HARBOR GREY

AUTUMN HARVEST

SCOTTISH THISTLE

SAGE

PEBBLESTONE CLAY

NATURAL CEDAR

JEFFERSON TAN

EVEREST

AUTUMN GOLD

CAPE COD GREY

VICTORIAN GREY

WICKER

TUSCAN OLIVE

ALMOND

CORN SILK

ASPEN GREY

DESERT SAND

SANDTONE

SILVER GREY

CLASSIC CREAM

LINEN

CAMEO

COLONIAL YELLOW

WHITE

WINDOW WHITE

WINDOW ALMOND

WINDOW BROWN

A HEALTHY RESPECT FOR THE PLANET — AND OUR CUSTOMERS.



Mastic Home Exteriors by Ply Gem can help you meet your sustainable building goals and earn points in leading green building certification programs. Our products offer features that positively contribute to sustainable practices, improved energy efficiency or lifecycle benefits of homes. All are important aspects of sustainable building and reflect Mastic's contribution to the Ply Gem Enviro initiative.

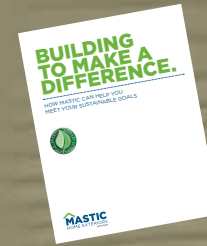

For more information on how Mastic products can help you meet your sustainable building goals, refer to the Mastic *Building to Make a Difference* white paper available at mastic.com.



SUSTAINABLE RESOURCES:

- Mastic vinyl siding is manufactured from two abundant natural resources: salt (57%) and natural gas (43%).¹
- During the manufacturing process of our vinyl siding, all unused material is reclaimed and reused, creating one of the most efficiently-produced exterior claddings available today.
- The Structure[®] Home Insulation System[™] has been third-party verified and Green Circle certified to contribute towards achieving LEED[®] and NAHB credits, utilizing post-consumer and post-industrial recycled material.
- When installed and used properly, Mastic products never require paint or stain, which reduces VOCs released into the atmosphere.
- Mastic Performance Metals[®] have been third-party verified and Green Circle certified to contain a minimum of 67% recycled content.
- Ply Gem facilities reuse and recycle pallets and packaging material, reducing raw material needs and landfill use.



ENERGY EFFICIENCY:

- Vinyl siding requires less energy to manufacture per square foot than brick and mortar.²
- Mastic vinyl siding is lighter weight per square than other cladding options, so it requires less fuel to transport. Less fuel used means less pollution.
- When correctly installed, the Structure[®] Home Insulation System[™] can reduce thermal bridging and help meet the requirements of an ENERGY STAR[®] Qualified new home. The Structure[®] Home Insulation System[™] in a Double 6" profile has an R-value³ of R-3.0 using the testing method ASTM C1363, as specified by the Federal Trade Commission.
- Mastic Performance Metals[®] V-Groove soffit and roof and eave vents support proper attic ventilation efforts, which moderates attic temperatures and improves a home's energy efficiency. Mastic V-Groove metal soffit provides the most net free ventilation per linear foot of any aluminum soffit system.



LIFECYCLE BENEFITS OF HOMES:

- Mastic vinyl siding is durable and requires no site finish. Our Performance Metals[®] stand up to weather with virtually no maintenance. Our Designer Accents use thicker construction and a baked lacquer finish to ensure that they hold up season after season.
- When installed properly and under normal use, our products should never require painting or staining. They won't crack, peel, blister, or rot.
- All of our Performance Metals[®] aluminum accessories are easily recyclable. In fact, at the end of its lifecycle in building applications, 100% of the aluminum can be recycled.

¹"A Dozen Things You Might Not Know That Make Vinyl Siding Green," page 9, Tad Radzinski, P.E., LEED AP, and VSI, October 10, 2009. <<http://www.vinylsiding.org/greenpaper/>>

²Ibid, page 10

³R means resistance to heat flow. The higher the R-value, the greater the insulating power.



Home Innovation
 NGBS GREEN CERTIFIED[™]
 ENERGY EFFICIENCY

This product has been certified by Home Innovation Research Labs. This means you can be assured that this product complies with specific green practice criteria in the National Green Building Standard (NGBS). Visit www.HomeInnovation.com/GreenProducts for more details.



Looking for Mastic products with features that can contribute to overall energy savings, lower maintenance and reduced environmental impact? These logos identify products recognized by third parties as supporting green building practices.



Member
NAHB
 National Association
 of Home Builders

Mastic supports green building and it shows. We are active members of both the USGBC and NAHB — two key organizations that are working to define sustainable building practices.

enviro snap SHOT ALUMINUM SIDING

LEED FOR HOMES — POSSIBLE POINTS

1 - 8 61

LEED NEW CONSTRUCTION — POSSIBLE POINTS

4 26

NAHB STANDARDS — POSSIBLE POINTS

9 - 31 42

enviro snap SHOT ALUMINUM SOFFIT

LEED FOR HOMES — POSSIBLE POINTS

1 - 8 61

LEED NEW CONSTRUCTION — POSSIBLE POINTS

4 26

NAHB STANDARDS — POSSIBLE POINTS

9 - 31 42

enviro snap SHOT ALUMINUM ACCESSORIES

LEED FOR HOMES — POSSIBLE POINTS

1 - 8 61

LEED NEW CONSTRUCTION — POSSIBLE POINTS

2 26

NAHB STANDARDS — POSSIBLE POINTS

13 - 34 42



The Exterior Solution[®]



SHINGLE SIDING

SHUTTERS

FASCIA

TRIM

SOFFIT

STONE VENEER

WINDOWS

CELLULAR PVC TRIM



- Cedar Discovery[®] Triple 5" - Cedar
- Structure[®] Double 4" - Pebblestone Clay
- Designer Accents Louvered Shutters - Red
- Trim - Cameo
- Ply Gem Stone - Shadow LedgeStone - Bradford

Get Started



Scan the QR code to get started on your dream home exterior or visit www.mastic.com/getstarted.



1 DREAM

DESIGNED EXTERIOR™ FIELD GUIDE

A series of amazing exterior transformations that will inspire ideas for your own home.



2 COLOR

MASTIC COLOR ADVISOR IPAD® APP

Offers a choice of three simple ways to find a color palette that fits you and your home exterior perfectly.



3 VISUALIZE

THE DESIGNED EXTERIOR STUDIO

Mix and match colors and styles to see how they look together.



4 PREVIEW

DREAMHOME PROFESSIONAL

Use a photo of your home to see a realistic image of a Designed Exterior on your house. *Ask your builder or remodeler.*



MASTIC HOME EXTERIORS. THIS IS THE EXTERIOR SOLUTION.®



SIDING | PERFORMANCE METALS | RAIN REMOVAL | DESIGNER ACCENTS | DOOR SURROUNDS | SOFFIT + FASCIA | SHUTTERS



mastic.com • 800 962 6973

PLY GEM SIDING GROUP
2600 GRAND BLVD. SUITE 900
KANSAS CITY, MO 64108

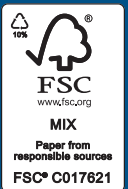

PLY GEM RESERVES THE RIGHT TO ALTER, MODIFY OR DELETE ITEMS FROM TIME TO TIME WITHOUT NOTICE. DUE TO PRINTING LIMITATIONS, COLORS MAY NOT BE EXACTLY AS SHOWN. CONTACT YOUR DISTRIBUTOR OR SALES REPRESENTATIVE FOR ACTUAL PRODUCT AND COLOR SAMPLES.

MASTIC, MASTIC HOME EXTERIORS, THE MASTIC HOME EXTERIORS LOGO AND THE "MASTIC HOME EXTERIORS. THIS IS THE EXTERIOR SOLUTION." SLOGAN ARE TRADEMARKS OF MASTIC HOME EXTERIORS, INC. PLY GEM IS A TRADEMARK OF PLY GEM INDUSTRIES, INC. AND/OR ITS SUBSIDIARIES. ©2015 MASTIC HOME EXTERIORS. ALL PRODUCTS MADE IN THE U.S.A. 7601099991105/BT/CG/0415



The DesignedExterior™

SIDING | WINDOWS | DOORS | STONE | TRIM | ROOFING | FENCE | RAILING

